

send SMS; attach printScreen (part of) and/or any document that can be viewed by a Smartphone browser

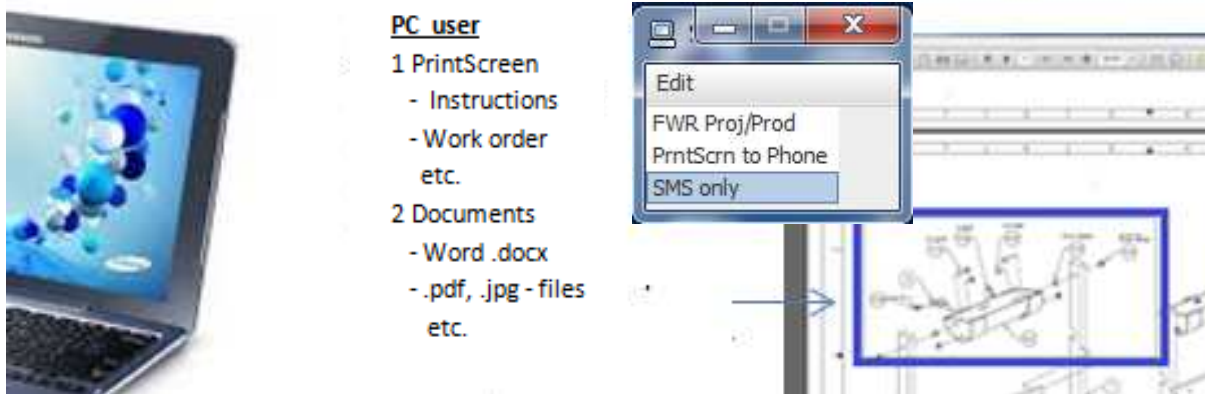

- PC user**
- 1 PrintScreen
 - Instructions
 - Work order
 - etc.
 - 2 Documents
 - Word .docx
 - .pdf, .jpg - files
 - etc.

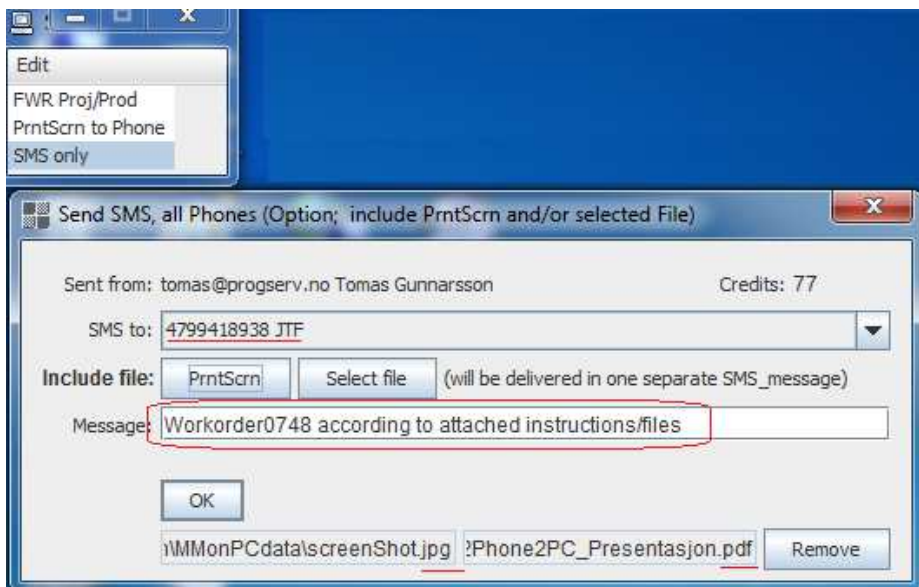

SMS – Work order(prntScrn), and .pdf file on any Smartphone

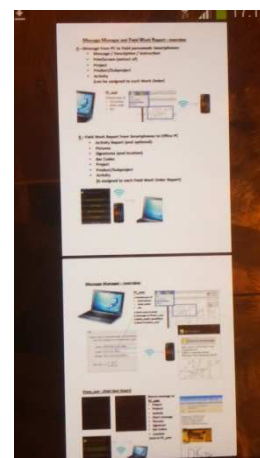
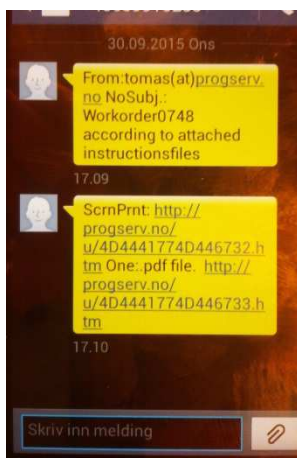

send SMS with Message Manager - overview



PC user

1 PrintScreen of

- Instructions
- Work order
- etc.

2 Mark area to send

3 Message to Phone_user

5 Send to Phone_user

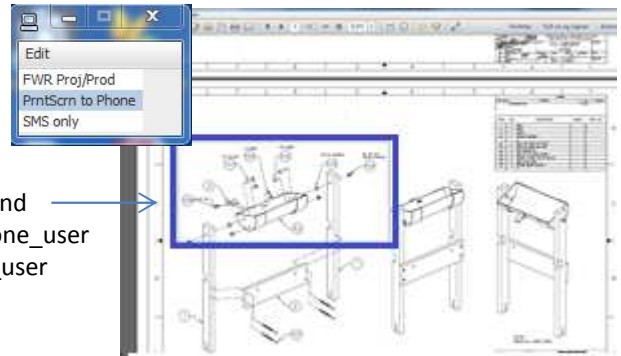

Explanation - Mark area on PC Screen to send – How to know and do this?

When you clicked «PrntScrn to Phone» this indicates when to click drag an release mouse button

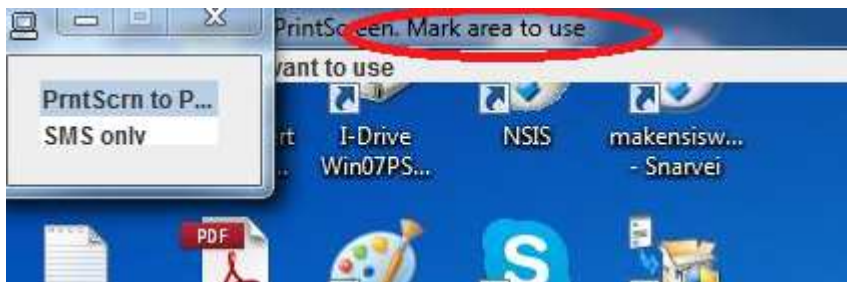

Installation of PC software Message Manager

Perform these steps:

Go to: <http://signpod.net/dl.htm>

1.



<http://signpod.net/dl.htm>

2.

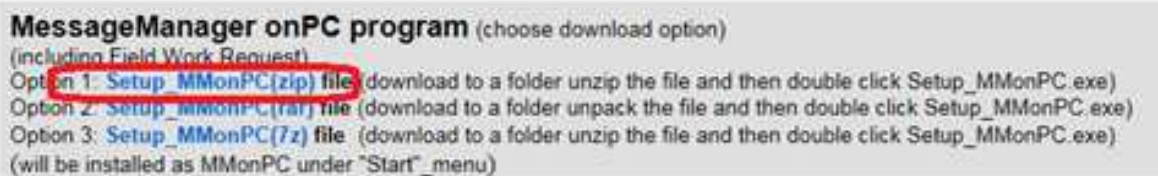

3.



4.



5.



6.

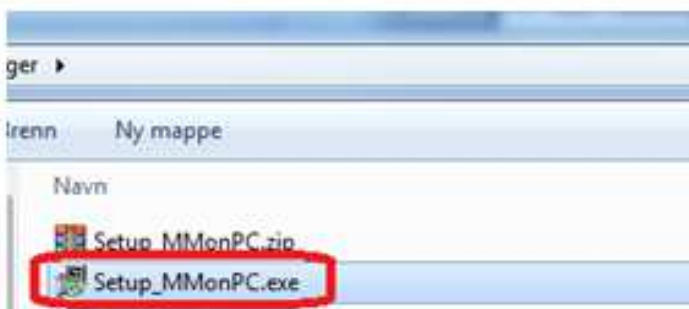

Continues on next page

7.

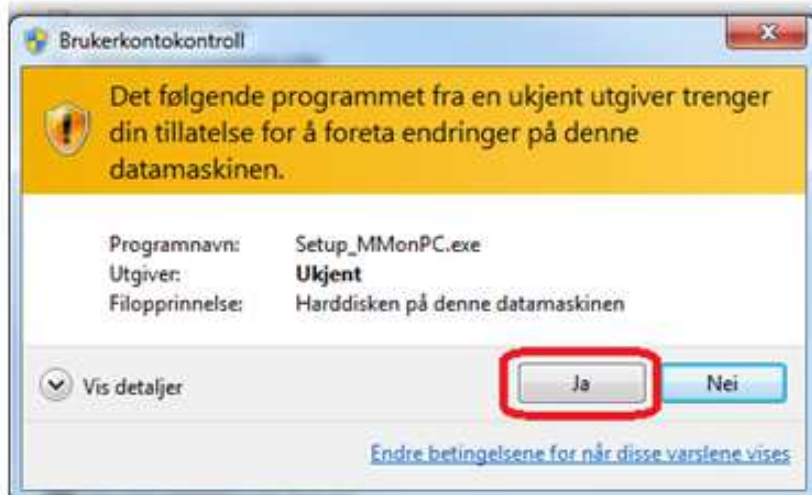

8.

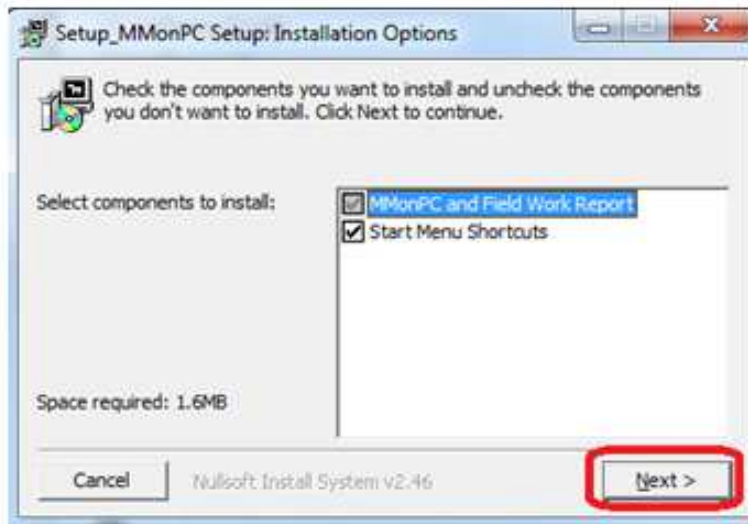

9.

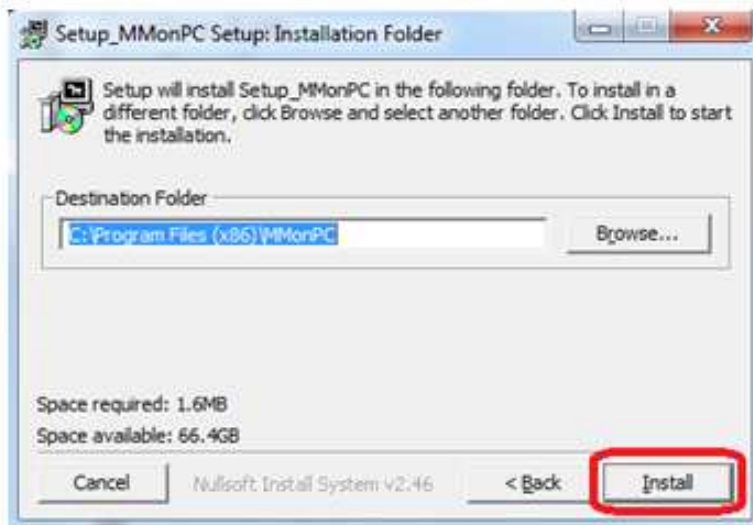

Continues on next page

10.

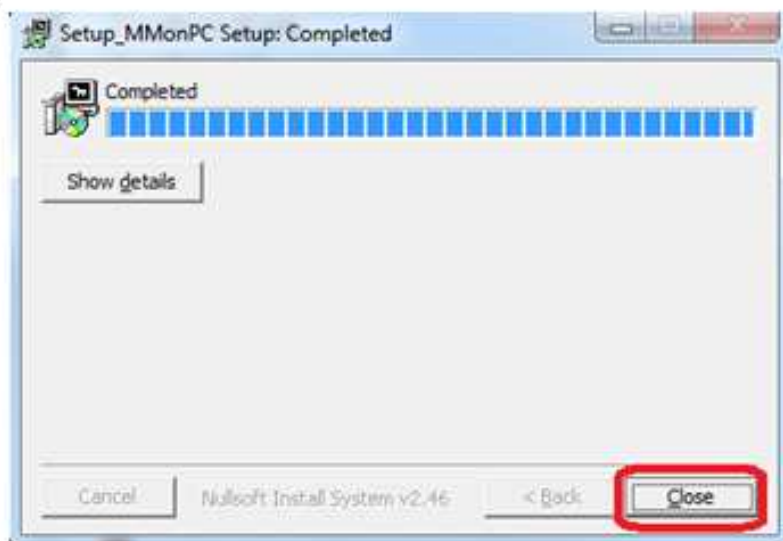

11.

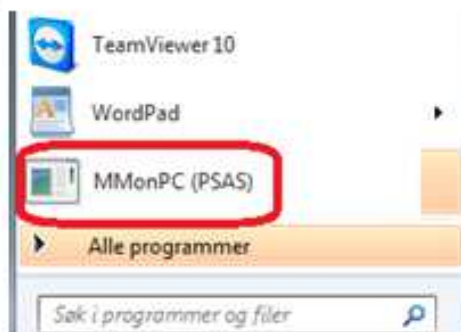

Or do this:

12.

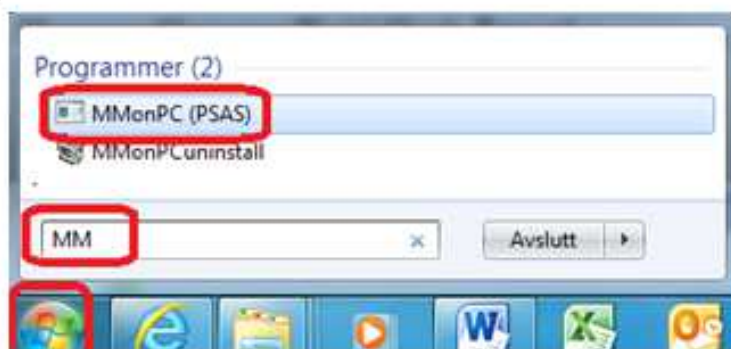

13.

Set Up of MMonPC
Se next page

14. Select "Register your mail"

15. Restart MessageManager on PC

16. Test

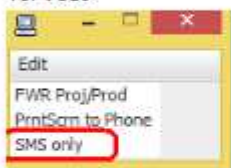

PC requirements

Java must be installed <http://java.com>

Firewall must support/allow FTP_transfer

When using MMonPCsetup.exe , administrator privileges are required

